

Distillation

Syllabus:

Raoult's law, phase diagrams, volatility, simple, steam and flash distillations, principles of rectification, McCabe Thiele method for calculations of number of theoretical plates, Azeotropic and extractive distillation.

Definition

Distillation may be defined as the separation of the constituents of a mixture including a liquid by partial vaporization of the mixture and separate and collect the vapor.

Such separation may include

- (i) one liquid from non-volatile impurities.
- (ii) one liquid from one or more other liquids, with which it may be miscible, partially-miscible or immiscible

N.B.

In practice it is difficult to distinguish between evaporation, distillation and drying.

Based on the intention:

- (i) when condensation vapor is required the operation is called distillation
- (ii) when the concentrated liquid residue is required the operation is called evaporation.
- (iii) when the dried solid residue is required as product the process is called drying

BOILING POINT DIAGRAM OF A BINARY MIXTURE

The figure represents the boiling point and equilibrium-composition relationship, at constant pressure.

Two liquids A (b.p. t_A) and B (b.p. t_B) are taken in a chamber of constant pressure. Now at any temperature the vapor composition and liquid

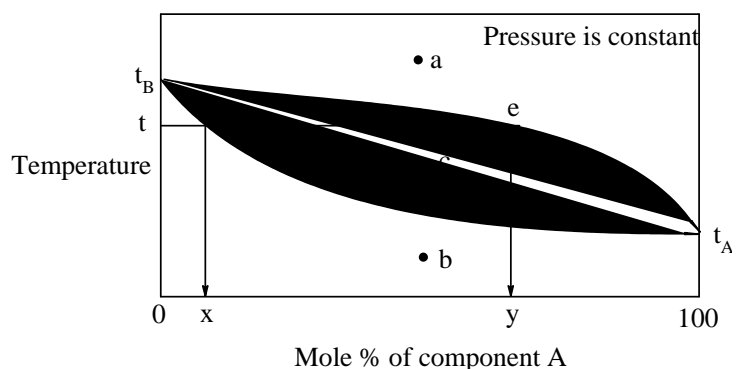

composition will give two lines when plotted vs. temperature.

In boiling point diagram, temperatures are plotted as ordinates and compositions as abscissas.

- The diagram consists of two curves, the ends of which coincide with the b.p. of two components (t_A and t_B).
- The upper-curve describes vapor composition and lower-curve liquid composition.
- At any temperature, 't' the horizontal line cuts the vapor composition curve at 'e' which corresponds to vapor composition of y (mole%A) and cuts the liquid composition curve at 'd' which corresponds to liquid composition of x (mole% of A). So any two points on the same horizontal line (such as d and e) represent compositions of liquid and vapor in equilibrium at temperature 't'.
- For all points above the top line (such as point 'a') the mixture is entirely vapor.
- For all points below the bottom line (such as point 'b') the mixture is completely liquefied.
- For all points between the two curves (such as point 'c') the system consists partly of liquid and partly of vapor.

RAOULT'S LAW

Raoult's law states that, at any particular temperature, the partial pressure of one component of a binary mixture is equal to the mole fraction of that component multiplied by its vapor pressure in the pure state at this temperature.

i.e Partial vapor pressure of a liquid (p_A)

= vapor pressure of pure liquid(P_A^0) x mole fraction of the liquid(x_A)

or, $p_A = P_A^0 x_A$

e.g. to illustrate Raoult's law, let us consider the case of benzene and toluene mixture.

At a temperature of 100°C toluene has a vapor pressure of 556 mm Hg. Consequently, if partial pressure is plotted against composition, the partial pressures of toluene at various compositions will fall along a straight line from 556 mm for pure toluene to zero for pure benzene. At this same temperature benzene has vapor pressure of 1350 mm, and its vapor pressure will change linearly from zero for 0% benzene to 1350 mm for pure benzene.

The total pressure for any composition will be the sum of the two partial pressures at that composition.

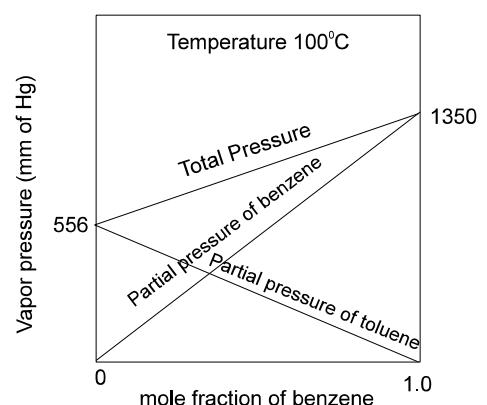

If the partial pressures are straight lines i.e. Raoult's law holds then the total pressure will be a straight line between 556 mm for pure toluene and 1350 mm for pure benzene.

Ideal solution: Ideal solution is defined as a solution that obeys Raoult's law.

Examples: In these solutions the components have similar structures e.g. benzene and toluene system, n-heptane and n-hexane, ethyl bromide and ethyl iodide etc.

- In this case total pressure is equal to sum of the partial pressures of the components, i.e. $P = (p_A + p_B)$
- The total pressure curve will be a straight line.

Non-ideal or real solutions

Solutions those will not obey Raoult's law are known as non-ideal or real solutions.

Most real solutions show deviation. The deviations are observed due to uneven solute-solute, solute-solvent and / or solvent-solvent interactions. Two types of deviations are found:

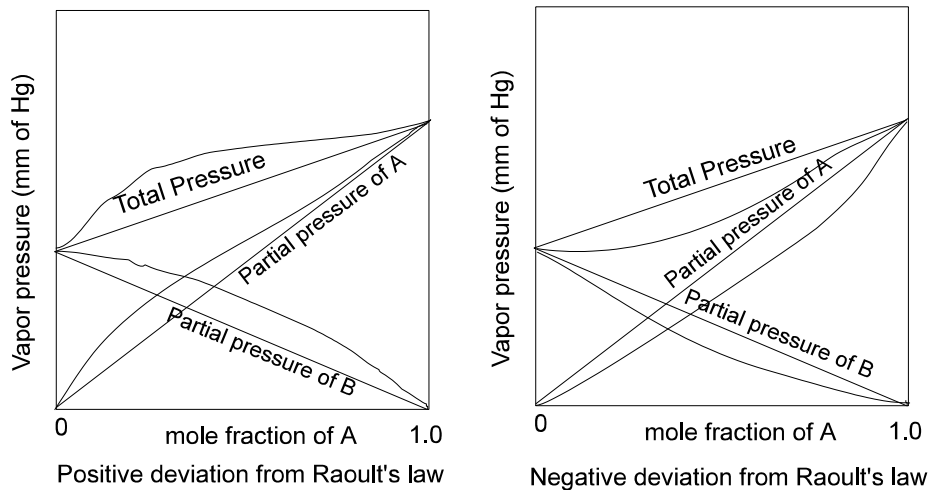

(i) Positive deviation

In these systems the overall vapor pressure is greater than the sum of the partial vapor pressures of the individual components, i.e. $P > (p_A + p_B)$

When the components differ in their polarity, length of carbon chain or degree of association, the system may show positive deviation.

Examples: Carbontetrachloride and cyclohexane, benzene and ethanol.

(i) Negative deviation

In these systems the over all vapor pressure is lower than the sum of the partial vapor pressures of the individual components, i.e. $P < (p_A + p_B)$

If hydrogen bonding, salt formation and hydration occurs then these systems may show negative deviation.

Examples: Chloroform and acetone, pyridine and acetic acid, water and nitric acid.

VOLATILITY

The *volatility* of any substance in solution may be defined as the equilibrium partial pressure of the substance in the vapor phase divided by the mole fraction of the substance in the solution.

$$\text{Volatility of component A, } v_A = \frac{\text{Partial vapor pressure of A}}{\text{Mole fraction of A in solution}} = \frac{p_A}{X_A}$$

Relative volatility

For a more volatile phase in equilibrium with a liquid phase, the relative volatility of component A (the more volatile component) with respect to component B is defined by the equation:

$$\alpha_{AB} = \frac{y_A / X_A}{y_B / X_B}$$

where

α_{AB} = relative volatility of component A with respect to component B

y = mole fraction of component A in vapor phase

x = mole fraction of component in liquid phase

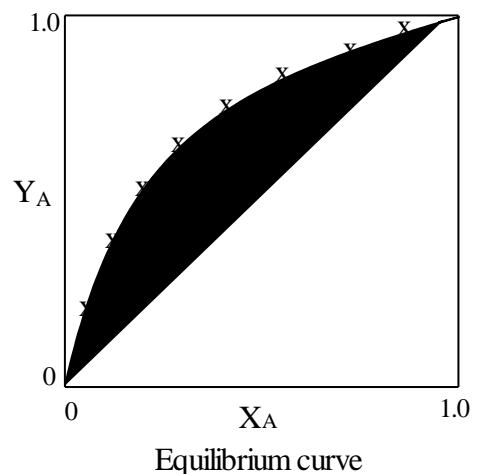

Relative volatility can also be expressed as

In case of binary system, $y_B = 1 - y_A$ and $x_B = 1 - x_A$.

Substituting,

$$\alpha_{AB} = \left(\frac{y_A}{1 - y_A} \right) \left(\frac{1 - x_A}{x_A} \right)$$

Rearranging we get $Y_A = \frac{\alpha_{AB} X_A}{1 + (\alpha_{AB} - 1) X_A}$

X_A						
Y_A						

From Dalton's law

$$y = \frac{P_A}{P_A + P_B} = \frac{P_A x}{P}$$

Therefore, $\frac{y}{x} = \frac{P_A}{P}$

y = mole fraction of component A in vapor phase

x = mole fraction of component A in liquid phase

So relative volatility can also be expressed as

$$\alpha_{AB} = \frac{P_A / P}{P_B / P} = \frac{P_A}{P_B}$$

Equilibrium curve

If α_{AB} is given then from the above equation a set of X_A and Y_A can be calculated. When Y_A is plotted against X_A the curve is called *equilibrium curve*.

Example

The vapor pressures of benzene and toluene are as given in the table. Assuming that mixtures of benzene and toluene obey Raoult's law, calculate and plot the boiling-point diagram for this pair of liquids at 760mm total pressure.

Solution:

Let us take one temperature 180⁰F

So at 180⁰F, $P_A = 811$ Hg

$P_B = 345$ mm Hg

We have to calculate the mole fraction of benzene in liquid (x) and in vapor (y).

From the eqn.:

$$P = P_A x + P_B (1 - x)$$

or, $760 = 811 x + 345 (1 - x)$

or, $x = 0.891$

From eqn. $y = \frac{P_A x}{P} = \frac{811 \times 0.891}{760} = 0.951$

Similarly for all temperature values corresponding x and y values may be calculated:

Temp	Benzene P _A	Toluene P _B	x	y
176.2	760	314	1.000	1.000
180	811	345	0.891	0.950
185	882	378	0.758	0.880
190	957	414	0.637	0.802
195	1037	452	0.526	0.718
200	1123	494	0.423	0.625
205	1214	538	0.328	0.525
210	1310	585	0.241	0.416
215	1412	635	0.161	0.299
220	1520	689	0.085	0.171
225	1625	747	0.015	0.032
230	1756	760	0.000	0.000

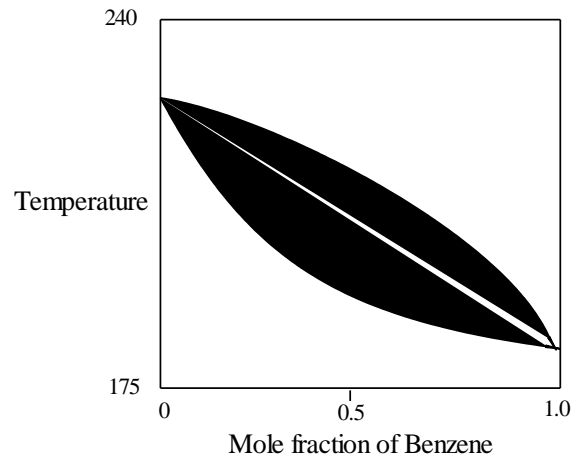

Boiling point diagram for benzene-toluene system at 1 atm pressure

Example

Construct an equilibrium curve for binary system of benzene – toluene from the given data.

Data	Boiling point at 1 atm	Vapor pressure of benzene (P _A)	Vapor pressure of toluene (P _B)	$\alpha_{AB} = \frac{P_A}{P_B}$
Benzene	80.1 ⁰ C	760 mm	270 mm	2.81
Toluene	110.6 ⁰ C	1780 mm	760 mm	2.34

Therefore, average relative volatility over the temperature range 80.1 to 110.6⁰C

$$\alpha_{AB(avg)} = \frac{2.81 + 2.34}{2} = 2.57$$

Therefore, $Y_A = \frac{2.57 X_A}{1 + (2.57 - 1) X_A} = \frac{2.57 X_A}{1 + 1.57 X_A}$

X _A	0.1	0.2	0.3	0.4	0.5	0.6	0.7	0.8	0.9
Y _A	0.222	0.391	0.524	0.631	0.720	0.794	0.857	0.911	0.959

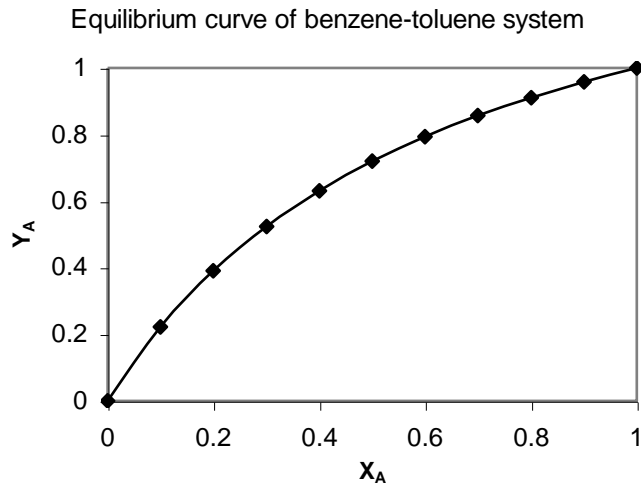

DISTILLATION METHODS

A. Distillation methods for miscible liquid systems

1. Simple Distillation
2. Flash Distillation / Equilibrium Distillation
3. Fractional Distillation / Rectification
4. Distillation under reduced pressure (e.g. Molecular Distillation)
5. Special Distillation Methods for non-ideal mixtures
 - (a) Distillation of Azeotropic Mixtures
 - (b) Extractive Distillation

B. Distillation of immiscible liquids (e.g. Steam Distillation)

SIMPLE / DIFFERENTIAL DISTILLATION

Simple distillation is a process in which a single component from a liquid (or mixture) is converted into vapor, the vapor is transferred to another place and recovered by condensing it.

In this process vapor is removed from the system as soon as it is formed and condensed.

Use:

- This method is commonly used in laboratory
- In industries it is only used for systems having high relative volatilities.

Objective

Simple distillation is the process of converting a liquid into its vapors which, are passed through a cooling surface to condense the vapors. The condensed vapors are reformed into liquid which, is collected in a receiver.

Apparatus for laboratory scale

It consists of a distillation flask with a side arm sloping downward that is connected to a condenser. The condensed vapors are collected in a flask called '*receiver*'. The whole apparatus is made of glass.

A thermometer is fitted in the distillation flask to note down the temperature at which, the vapors are distilled.

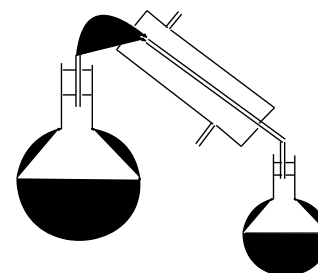

Bumping is avoided by adding small pieces of porcelain or porous pot before distillation.

Large scale equipment for simple distillation

Construction

The still is made up of stainless steel, copper, or any other suitable material. A thermometer is fixed to the still to note the temperature of the boiling liquid. An observation window in the hood is helpful to the operator to see the level of the boiling liquid. The still is connected to a condenser and then to a receiver. The bottom of the still is jacketed through which steam is introduced to heat the still.

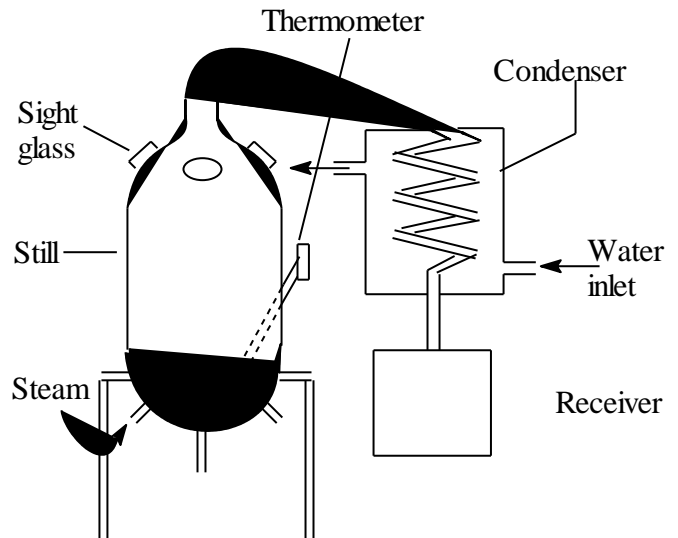

Fig. Simple distillation in large scale

Working

A liquid to be distilled is filled into the still to $\frac{1}{2}$ to $\frac{2}{3}$ rd of its volume. Bumping of the liquid is avoided by placing few small pieces of porcelain or glasses before the distillation. Water is circulated through the condenser.

Steam is passed through the inlet. The contents are heated gradually. The liquid begins to boil after some time. The vapor begins to rise and passes into the condenser. The temperature rises very quickly and reaches the boiling point of that liquid.

The vapor is condensed and collected into the receiver.

Apparatus for preparation of purified water

- The boiler may be made of cast iron but the baffles and the condenser tubes that comes into contact with product are made of stainless steel or monel metal.
- The cold water from the water tap enters the still through the inlet, which rises in the jacket fitted with a constant level device, the excess of water over flow through the outlet.
- A portion of hot water at 90 to 95⁰C enters into the boiler through a narrow opening – the level of water is maintained in the boiler up to overflow level.
- The water is boiled in the boiler by means of heating coils. On heating, the dissolved gases in the condenser are allowed to escape through a small opening and only the steam escapes into the condensing tubes.
- Since the dissolved gases are more volatile than water they escape in the first portion of the distillate, therefore, must be rejected. Similarly, the last portion may contain volatile portion of the dissolved solid substances in tap water – hence, discarded.

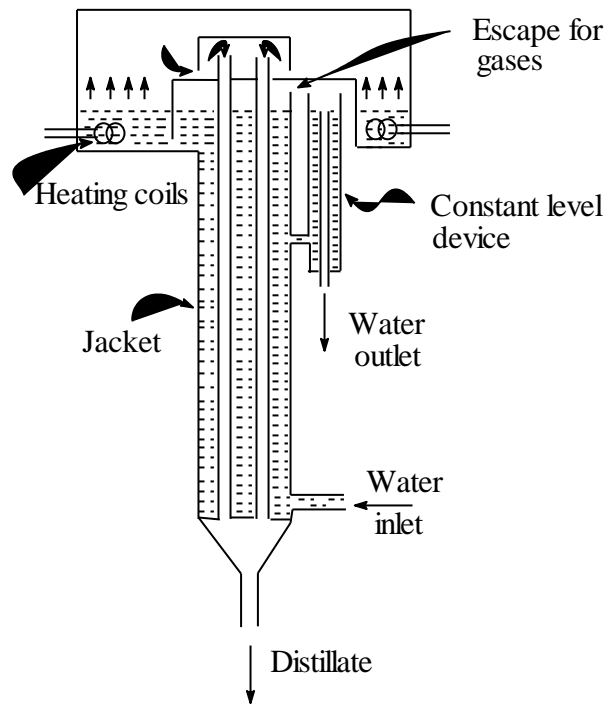
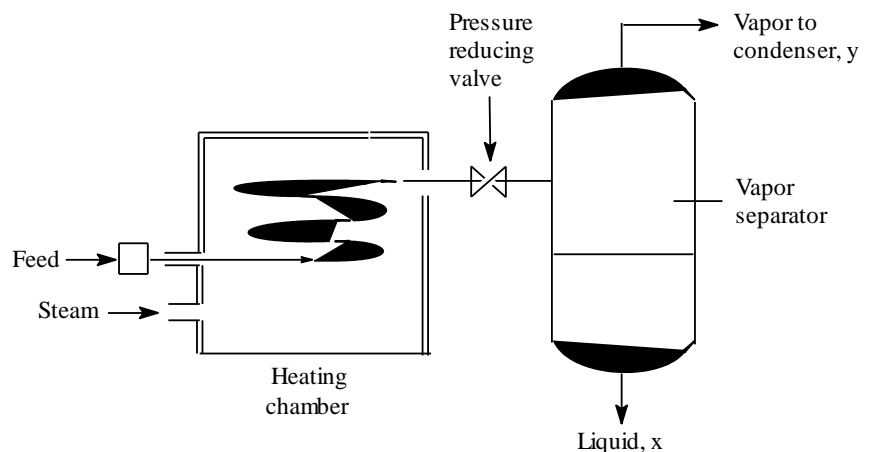

Fig. Distillation unit for purified water

Application of simple distillation in pharmacy

1. It is used for the preparation of distilled water and water for injection.
2. Many volatile oils and aromatic waters are prepared by simple distillation e.g. Spirit of nitrous ether and Aromatic Spirit of Ammonia
3. Concentration of liquid and to separate non-volatile solid from volatile liquids such as alcohol and ether.

FLASH DISTILLATION / EQUILIBRIUM DISTILLATION



Saraswati Institute of Pharmaceutical Sciences, Gandhinagar
Fig. Apparatus for flash distillation

Principle: When a hot mixture is allowed to enter from a high-pressure zone into a low pressure zone, the entire liquid mixture is suddenly vaporized. This process is known as *flash vaporization*. During this process, the chamber is cooled. The less volatile fraction is condensed and the more volatile component remains in the vapor phase. This process requires time, hence liquid and vapor are kept in intimate contact until equilibrium is achieved.

Flash distillation is also called equilibrium distillation because separation of two liquids takes place when liquid and vapor phases are at equilibrium.

Construction: It consists of a pump, which is connected to a feed reservoir. Pumps help in pumping the feed into the heating chamber. The heating chamber is heat is supplied by steam. The other end of the pipe is directly introduced into the vapor-liquid separator through a reducing valve. The vapor outlet is provided at the top of the separator and liquid outlet is provided at the bottom.

Working: The feed is pumped through a heater at a certain pressure. The temperature of the liquid is raised in the heating chamber but the liquid does not boil under high pressure (because boiling point increases). When the liquid enters into the vapor-liquid separator, due to drop in pressure, the liquid reaches the boiling point under that reduced pressure and the liquid suddenly boils. The vapor flashes out from the hot liquid. Since the vapor takes the latent heat the liquid gets cooled down. The less volatile component of the vapor is condensed and more volatile component remains in the vapor phase. The mixture is allowed for sufficient time so that vapor and liquid comes at equilibrium. The vapor is separated through an outlet provided at the top and the liquid is collected at the bottom.

FRACTIONAL DISTILLATION / RECTIFICATION

Principle:

In this process when a liquid mixture is distilled, the partial condensation of the vapor is allowed to occur in a fractionating column. In the column, the ascending vapor from the still is allowed to come in contact with the condensing vapor returning the still. This results in enrichment of the vapor with more volatile component and the liquid is enriched with less volatile component. By

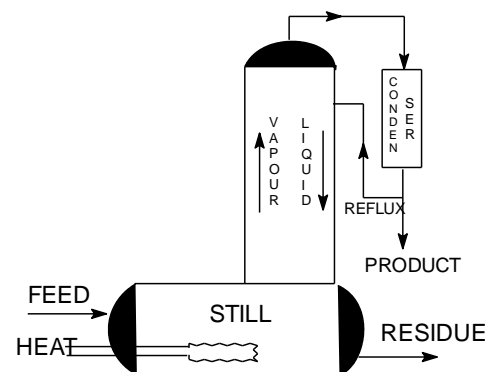

condensing the vapor and reheating the liquid repeatedly, equilibrium between liquid and vapor is set up at each stage, which ultimately results in the separation of a more volatile component.

A rectifying unit consists primarily of

- (a) a still or reboiler, in which vapor is generated,
- (b) a rectifying or fractionating column through which this vapor rises in counter-current contact with a descending stream of liquid, and
- (c) a condenser, which condenses all the vapor leaving the top of the column, sending part of this condensed liquid (the reflux) back to the column to *descend* counter to the rising vapors, and delivering the rest of the condensed liquid as product.

As the liquid stream descends the column, it is progressively enriched with the less volatile constituent.

The top of the column is cooler than the bottom, so that the liquid stream becomes progressively hotter as it descends and the vapor stream becomes progressively cooler as it rises. This heat transfer is accomplished by actual contact of liquid and vapor, and for this purpose effective contact is desirable.

CONSTRUCTION OF RECTIFYING COLUMN

There are different varieties of equipments for rectification

- (a) Plate column (i) Bubble cap column (ii) Sieve-plate column
- (b) Packed column

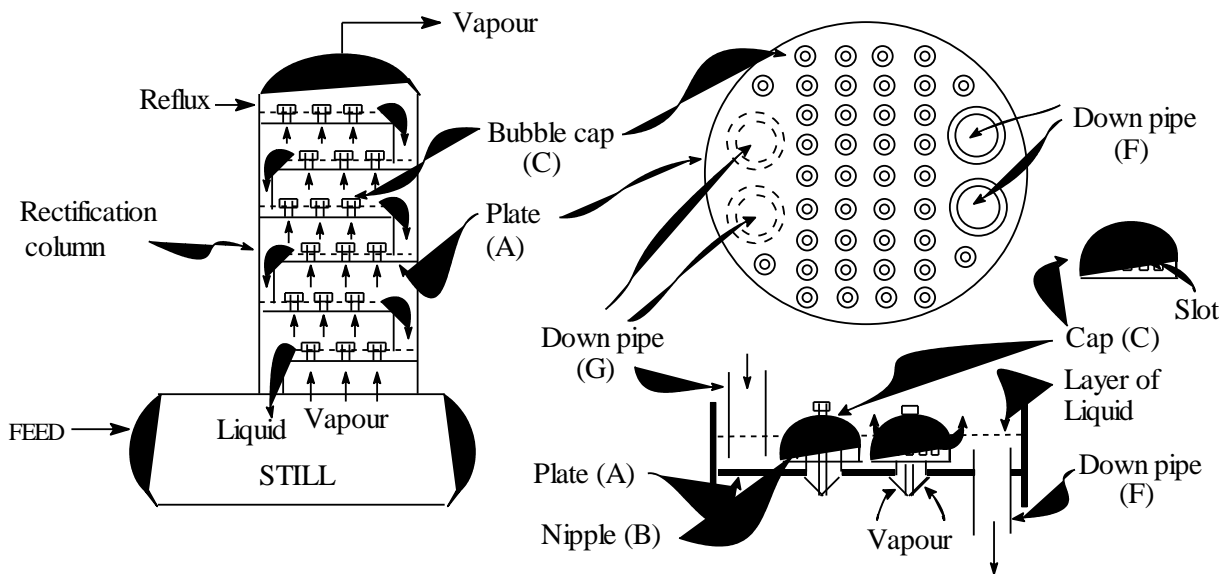

BUBBLE-CAP COLUMN

- The column is divided into sections by means of a series of *horizontal plates A*.
- Each plate carries a number of short *nipples B* (or *riser*). Each nipple is covered by a bell-shaped *cap C* that is secured by a spider and bolt with the plate. The edge of the cap is *serrated* or the sides may be *slotted*.
- Vapor rises from the plate below through the nipple, is diverted downward by the cap, and bubbles out under the serration or through the slots.
- A layer of liquid is maintained on the plate by means of an *overflow* or *down-pipe (F)* and the depth of the liquid is such that the slots are submerged.
- The *down-pipe, (G)* from the plate above, is sealed by the liquid on the plate below, so that the vapor cannot enter the down-pipe.
- Ordinarily, the liquid is delivered at one end of a diameter by the down-pipe from the plate above, flows the other end of the same diameter.

Types of down-comers

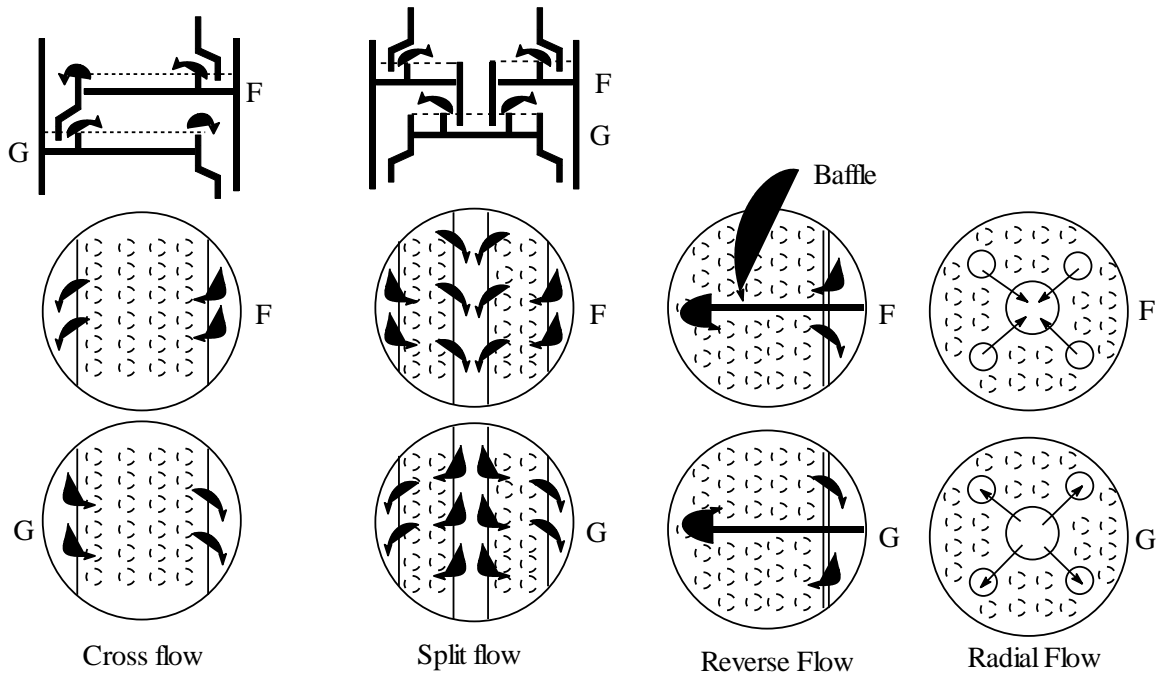

(a) Cross flow

The liquid flows across the plate from right to left on plate F and left to right on plate H and so on down the column.

(b) Split flow

On plate F the liquid flows from the two sides to the center. On plate H it flows from the center to the two sides and so on down the column. This arrangement is commonly known as split flow.

(c) Reverse flow

Liquid comes down the space on one side of the baffle and flows across the plate from right to left, around the end of the baffle, from left to right and down the space behind the weir. This arrangement is called reverse flow.

(d) Radial flow with circular down-take

One plate will have four or more down-comers around the circumference, and the next plate will have a down-comer at the center so that on the upper plate the flow is from the circumference towards center and on the next plate the flow is from the central down-take to the circumference.

Specification of bubble cap rectification column

Column diameter 2 to 15 ft

Height few feet to over 100 ft

Bubble cap diameter 3 to 6 inches

Slots in a 3 inches bubble cap may be $1/8$ to $3/32$ inch wide
 $1/2$ to 1 inch height

SIEVE PALTE COLUMNS

All the constructions are same as bubble cap columns. Instead of bubble cap plates, flat plates with a large number of relatively small perforations, drilled in them are used. These perforations are usually $3/16$ to $1/4$ inch in diameter.

The velocity of the vapor through these holes is sufficient to produce the liquid running down the holes.

PACKED COLUMNS

The column is entirely filled with some sorts of material that offers a large surface area supposedly wetted by the liquid.

A large variety of materials are used among which **Raschig rings** are popular. A Raschig ring is a hollow cylinder whose length is equal to its diameter. This may be made of metal (by sawing sections off a pipe), stone ware, ceramics, carbon, plastics, or other materials. Raschig rings are usually dumped at random in the column.

Raschig Ring Lessing Ring Pall Ring Berl Saddle Intalox Saddle

Advantages

- (i) Have a low pressure drop per unit of height than bubble cap
- (ii) For very small diameters of column, where it would be difficult to get in more than two or three bubble caps, a packed column can be used.
- (iii) Since Raschig rings can be made of any material, hence packed columns can be used for corrosive materials.
- (iv) The amount of liquid held up in the column is low so thermolabile liquid remains in contact with high temperature for a short time than bubble cap method.

Disadvantages

- (i) They are relatively inflexible.
- (ii) Distribution of liquid uniformly in such packed column is difficult. It is found that, as the liquid passes down the tower it tends to concentrate at the walls and leave the center dry.

McCABE – THIEL METHOD OF CALCULATION OF NUMBER OF PLATES

The feed contains two miscible components A and B. A is more volatile and B is less volatile component. The feed is entered on a plate in the central position of the column. This plate is called *feed plate*. The liquid film flows down the column. Vapor rises from the boiler at the bottom of the column.

Rectification unit: At the plates above the feed plate forms the rectification unit. At these plates the reflux liquid is flowing down. Ideally it should be free of component A. But small amount of A remains. This small amount of A is also taken out by the vapor. Hence this unit is called rectification unit (some kinds of mistake is rectified).

Stripping unit: In the feed plate and the lower plates the feed liquid (full of component A) flows downward. On the way it passes through the vapor that extracts the component A, hence it is called stripping section.

Material Balances in Plates

All the component flow rate is expressed in moles and the concentration in mole fraction.

Step-I : Over all material balance

Overall material balance:

Total material balance: $F = D + B$

Component A balance: $Fx_F = Dx_D + Bx_B$.

Eliminating B we get: $\frac{D}{F} = \frac{x_F - x_B}{x_D - x_B}$

Eliminating D we get: $\frac{B}{F} = \frac{x_D - x_F}{x_D - x_B}$

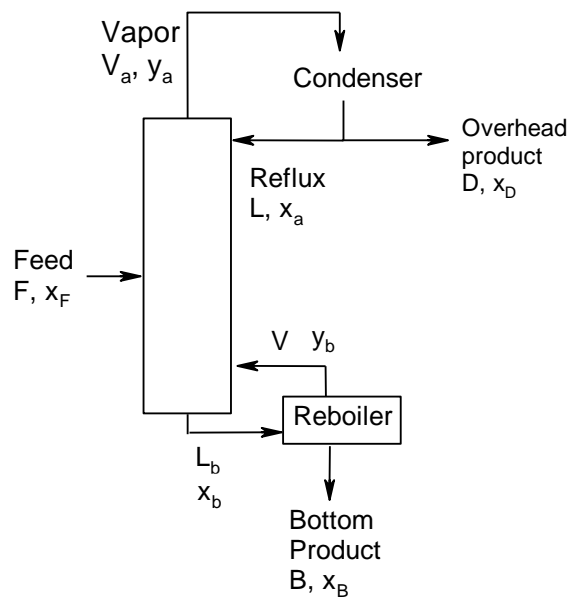

N.B. Why we are expressing in $\frac{D}{F}$ and $\frac{B}{F}$ format?

Because the D and B are expressed in terms of of F (i.e. Feed flow rate).

fraction

Step-II Net flow rate in rectification section

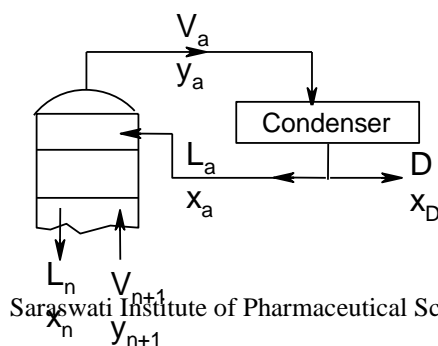

Rectifying section

* Material balance around condenser:

Material entering condenser = Material leaving condenser

or, $V_a = L_a + D$ or, $D = V_a - L_a$

* Material balance around upper section:

Material entering upper section = Material leaving upper section

$L_a + V_{n+1} = L_n + V_a$ or, $V_{n+1} - L_n = V_a - L_a = D$.

And $V_{n+1} = D + L_n$.

* Material balance with respect to component A

$V_{n+1} y_{n+1} - L_n x_n = Dx_D$.

or, $V_{n+1} y_{n+1} = L_n x_n + Dx_D$

or, $y_{n+1} = \frac{L_n}{V_{n+1}} x_n + \frac{Dx_D}{V_{n+1}}$

For convenience V_{n+1} is exchanged with $L_n + D$

$$y_{n+1} = \frac{L_n}{L_n + D} x_n + \frac{Dx_D}{L_n + D}$$

This equation is operating line-1 for rectifying section.

Step-III Net flow rate in stripping section

* Material balance around reboiler

Material entering the reboiler = material leaving the reboiler

or, $L_b = V_b + B$ or, $B = L_b - V_b$.

* Material balance around lower section

Material entering the lower section = Material leaving the lower section

$L_m + V_b = L_b + V_{m+1}$

or, $L_m - V_{m+1} = L_b - V_b = B$

or, $Bx_B = L_m x_m - V_{m+1} y_{m+1}$

or, $V_{m+1} y_{m+1} = L_m x_m - Bx_B$

or, $y_{m+1} = \frac{L_m}{V_{m+1}} x_m - \frac{Bx_B}{V_{m+1}}$

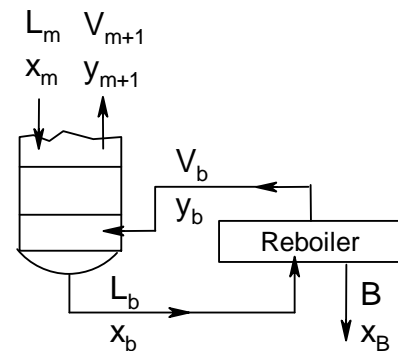

$$\text{or, } y_{m+1} = \frac{L_m}{L_m - B} x_m - \frac{Bx_B}{L_m - B} \quad \text{Operating line-2 for rectifying section}$$

Operating line-1 and operating line-2 shows that if $L_n \neq L_m$ then the operating lines will be curved and become difficult to draw unless the x_n , x_m , y_n and y_m of all the internal plates are known.

Assumption: Constant molal overflow

In order to simplify the equations for operating lines it is assumed that

The heat required to vaporize one mole of component A is nearly equal to the heat required to condense one mole of component B. In this case the enthalpy of component A and B is not required and the operating lines become linear.

⇒ Subscripts n, n+1, n-1 m, m+1 and n-1, L and V may be ignored and the simplified equations thus obtained are as follows:

$$\text{Operating line-1:} \quad y_{n+1} = \frac{L_n}{L_n + D} x_n + \frac{Dx_D}{L_n + D} \quad \Rightarrow \quad y = \frac{L}{L + D} x + \frac{Dx_D}{L + D}$$

$$\text{Operating line-2:} \quad y_{m+1} = \frac{L_m}{L_m - B} x_m - \frac{Bx_B}{L_m - B} \quad \Rightarrow \quad y = \frac{L}{L - B} x - \frac{Bx_B}{L - B}$$

Now let us put $x = x_D$ in operating line 1

$$\text{We get} \quad y = \frac{L}{L + D} x_D + \frac{Dx_D}{L + D}$$

$$\text{Or,} \quad y = \frac{L + D}{L + D} x_D$$

$$\text{Or,} \quad y = x_D$$

Similarly if we put $x = x_B$ in operating line-2

$$\text{then } y = x_B$$

x and y will be same at any point on diagonal. Thus, operating line-1 and 2 are cutting the diagonal at x_D and x_B respectively.

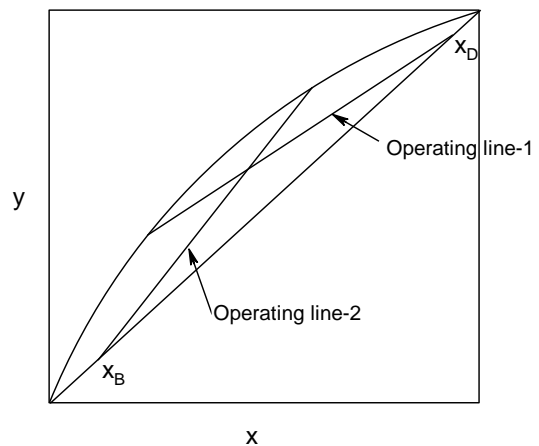

Feed plate

At the feed plate the liquid flow rate or the vapor flow rate or both may be changed depending on the thermal condition of the feed. All conditions of feed flow can be expressed by a term q, which

is defined as the moles of liquid flow in the stripping section that result from the introduction of each mole of feed. i.e.

$$q = \frac{\text{Moles of the feed reached below the plate}}{\text{Moles of Feed}} = \frac{\bar{L} - L}{F}$$

Case-1: Feed is cold liquid:

In this case the some amount of vapor condenses and add

to the liquid flowing down. Here $q = \frac{F + \text{Condensed } V}{F}$ So $q > 1$

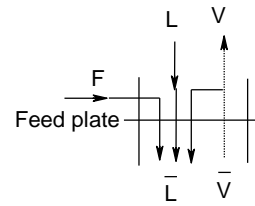

Case-2: Feed is boiling liquid:

In this case the feed liquid remains unchanged i.e no vaporization of feed nor any condensation of vapor.

Here $q = \frac{F}{F} = 1$ So $q = 1$

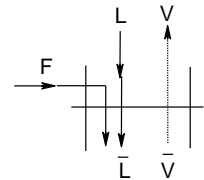

Case-3: Feed partially vaporized

In this case vapor part of the feed rise above with

Here $q = \frac{F - \text{Vapor portion}}{F}$ So, $0 < q < 1$

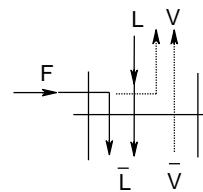

the vapor.

Case-4: Feed is vapor at dew point (i.e. saturated vapor)

In this case the total feed goes into vapor phase.

Here $q = \frac{F - F}{F} = 0$ So, $q = 0$

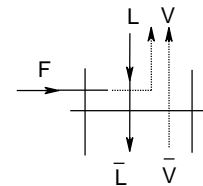

Case-5: Feed is super heated vapor

In this case the total feed goes into vapor phase and it vaporizes some amount of the reflux liquid also.

Here $q = \frac{F - F - \text{vaporize some amount of reflux liquid}}{F} < 0$ So, $q < 0$

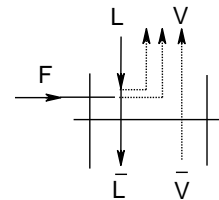

Feed line

Assumption: q fraction of feed is converted to liquid and (1 – q) fraction is vaporized.

* Material balance in the feed plate:

$\bar{L} = L + qF$ Therefore, $\bar{L} - L = qF$

$V = \bar{V} - (1 - q)F$ Therefore, $V - \bar{V} = (1 - q)F$

Operating line on the feed plate

Operating line-1: $y = \frac{L}{L+D}x + \frac{Dx_D}{L+D}$ or, $y = \frac{L}{V}x + \frac{Dx_D}{V}$ or, $Vy = Lx + Dx_D$ eqn-1

Operating line just below the feed plate

Operating Line-2: $y = \frac{L}{L-B}x - \frac{Bx_B}{L-B}$ or, $y = \frac{\bar{L}}{V}x - \frac{Bx_B}{V}$ or, $\bar{V}y = \bar{L}x - Bx_B$ eqn-2

Eqn-1 – Eqn-2: $y(V - \bar{V}) = (L - \bar{L})x + (Dx_D + Bx_B)$

Or, $(1-q)Fy = qFx + Fx_F$ [Since $Fx_F = Dx_D + Bx_B$]

Or, $y = -\frac{q}{1-q}x + \frac{x_F}{1-q}$ -----FEED LINE

If $X = X_F$ then from the feed line it is obtained $Y = X_F$.

The position of feed line depends only on X_F and q . The slope of the feed line is $\frac{-q}{(1-q)}$.

Construction of operating lines

Operating line-1: $y = \frac{L}{L+D}x + \frac{Dx_D}{L+D}$ describes the equation in the rectifying section

Operating line-2: $y = \frac{L}{L-B}x - \frac{Bx_B}{L-B}$ describes the equation in the stripping section

Operating line-3: $y = -\frac{q}{1-q}x + \frac{x_F}{1-q}$ describes feed line

Where y = mole fraction of more volatile component (A) in the vapor phase

x = mole fraction of more volatile component (A) in the liquid phase

L = moles of liquid on n^{th} plate

V = moles of liquid leaving the n^{th} plate.

D = moles of overhead product leaving the system

B = moles of bottom product leaving the system

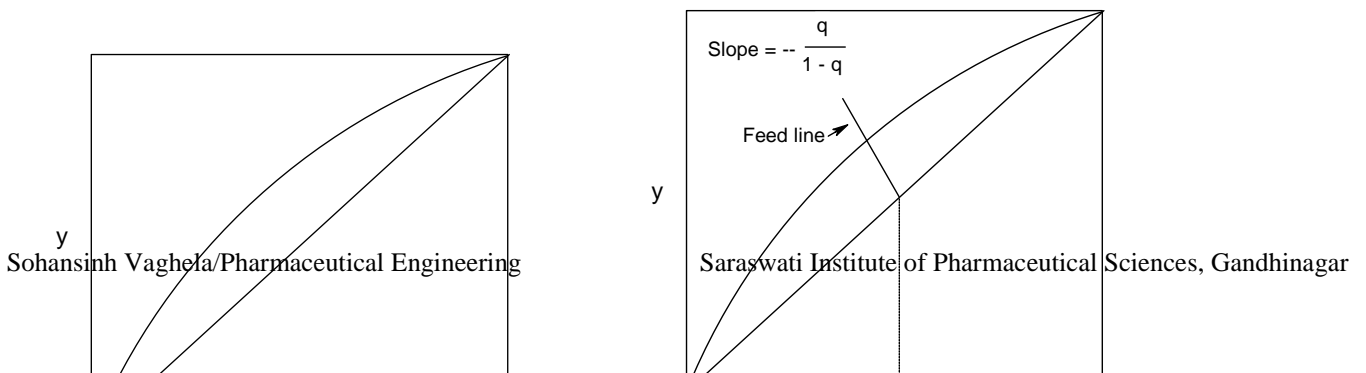

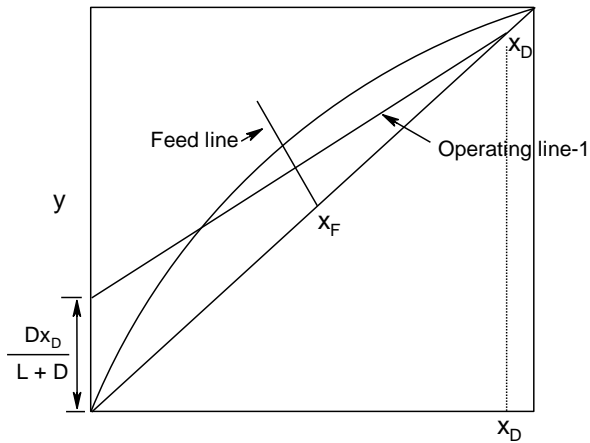

Step-3: Operating line-1 is drawn by joining the intersection point of x_D and diagonal line (i.e. $x = x_D$) and the intercept $Dx_D / (L + D)$

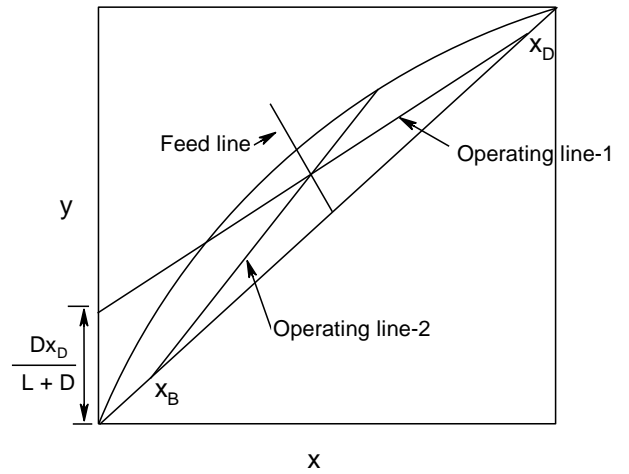

Step-4: Operating line-2 is drawn from the intersection point of X_B and the intersection point of feed line and operating line-1.

Step-5:

From X_D a horizontal line is drawn up to the equilibrium curve. From the point of intersection a vertical is drawn up to the first operating line. The triangular area enclosed is depicting the topmost plate.

Similarly from the intersection of first plate a horizontal line is drawn towards the equilibrium curve. From the intersection point a vertical line is drawn to construct the 2nd plate. Like wise one after another plates are drawn

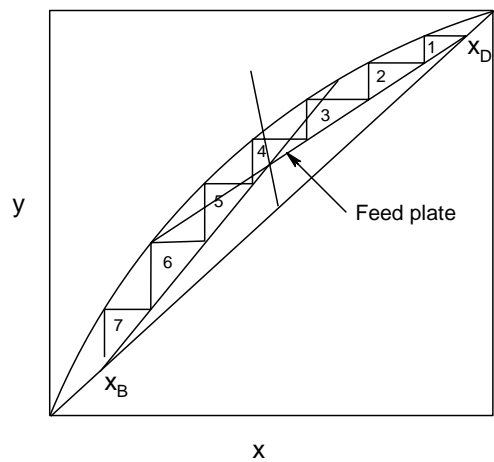

and when the vertical line crosses the feed line the line is drawn up to second operating line. Again the plates are drawn up to point X_B .

The total number of triangles are counted. In this figure the total number of theoretical plates is 7 and the position of feed plate is 4th.

INDUSTRIAL SCALE DISTILLATION OF AZEOTROPIC MIXTURE

The liquor from fermentation process is a common source of ethanol and contains approximately 8–10% ethanol.

After simple distillation an azeotrope will form containing 95.6% (96E+4W) ethanol and boiling at 78.15⁰C at atmospheric pressure.

In this type of system a reboiler is used instead of boiler. The feed liquor is introduced into the system and must occur at a point where the equilibrium will not be disturbed. Hence, feed will take place, at a place part of the way up the column, where the equilibrium composition on the plate is similar to the feed composition.

The plate below the *feed plate* form the stripping section where the rising vapor strips the more volatile component (ethanol) from the feed liquor while the upper section is known as the *rectifying section*.

The binary azeotrope produced at this stage is freed from water by making use of ternary azeotrope – ethanol, benzene, and water.

The ethanol/water azeotrope, with sufficient benzene (only required at start-up) is fed to column A and the pure ethanol is obtained as bottom product, since the ternary azeotrope takes off the water.

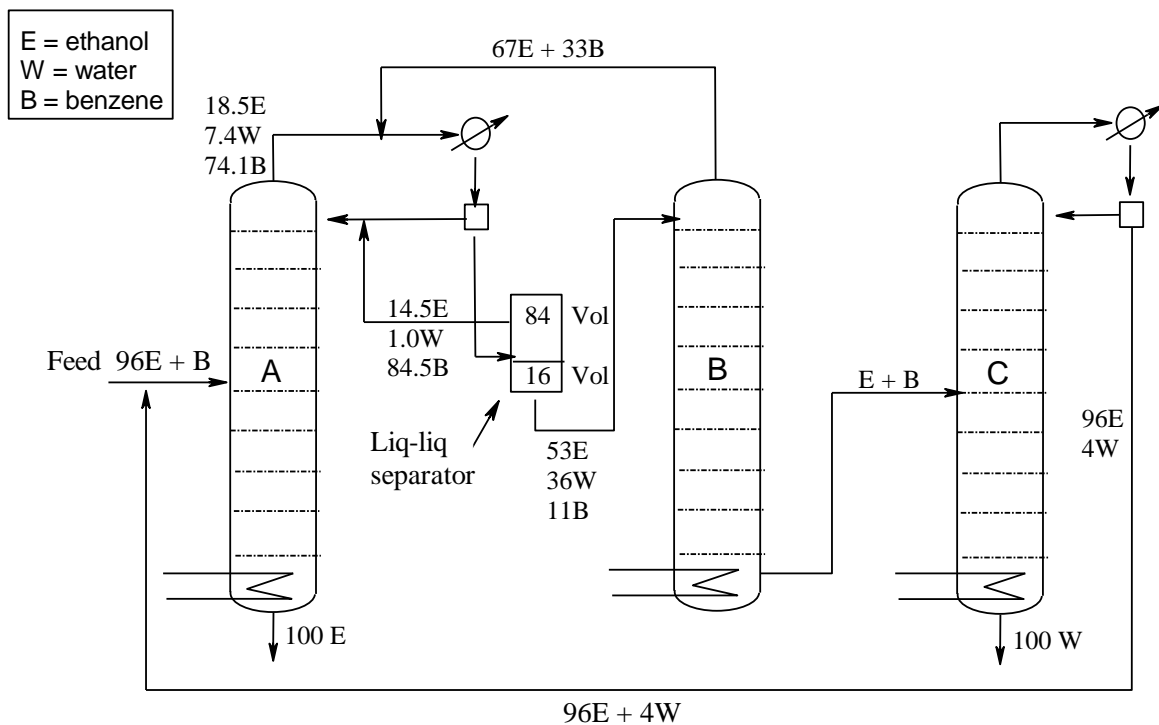

Fig. Plant for manufacture of Absolute ethanol (100% ethanol)

- The azeotrope (E+B+W) is taken from the top of the column A, condensed and separated (in liquid-liquid separator) into two layers, having the compositions given in the diagram.
- The upper layer predominates and, being rich in benzene (14.5E+1.0W+84.5B), is returned to column A. The lower layer (53E+36W+11B) is taken to column B, where the benzene is recovered as the ethanol/benzene binary azeotrope (67E+33B) and is mixed with the vapor from ethanol.
- The ethanol / water residue passes to column C, where the ethanol is recovered as the ethanol/water binary azeotrope (96E+4W), which can be incorporated with the original feed.
- The final product from column A is 100% ethanol and from column C is 100% water.

EXTRACTIVE DISTILLATION

Extractive distillation is same as azeotropic distillation except that the third agent that is added is relatively non-volatile liquid compared to the components to be separated.

e.g. (i) separation of toluene from iso-octane – the third agent is phenol.

(ii) separation of butadiene from a mixture of butane and butene – the third agent is furfural.

